

Single Line Uni-directional Transient Voltage Suppressor

DESCRIPTION

The GSD15T TVS diode is designed to replace multilayer varistors (MLVs) in portable applications such as cell phones, notebooks, and PDA's. It offers superior electrical characteristics such as low clamping voltage, low leakage current and high surge capability. It is designed to protect sensitive electronic components which are connected to power lines, from over-stress caused by ESD (Electrostatic Discharge), EFT (Electrical Fast Transients) and Lighting.

The GSD15T is in a SOD-323 package and will protect one unidirectional line. It may be used to provide ESD protection up to $\pm 30\text{kV}$ (Contact and air discharge) according to IEC61000-4-2, and used to protect USB voltage bus pin (8/20 us) according to IEC61000-4-5.

FEATURES

- ✧ Transient protection for high-speed data lines
IEC 61000-4-2 (ESD) $\pm 30\text{kV}$ (Contact)
 $\pm 30\text{kV}$ (Air)
- ✧ Peak power dissipation: 1800W (8/20 μs)
- ✧ Working voltages : 15V
- ✧ Low leakage current
- ✧ Low clamping voltage
- ✧ Solid-state silicon-avalanche technology

MACHANICAL DATA

- ✧ SOD-323 package
- ✧ Flammability Rating: UL 94V-0
- ✧ High temperature soldering guaranteed:
260 $^{\circ}\text{C}$ /10s
- ✧ Packaging: Tape and Reel
- ✧ Reel size: 7 inch

ORDERING INFORMATION

- ✧ Device: GSD15T
- ✧ Package: SOD-323
- ✧ Marking: H15
- ✧ Material: Halogen free and RoHS compliant
- ✧ Packing: Tape & Reel
- ✧ Quantity per reel: 3,000pcs

APPLICATIONS

- ✧ Power lines
- ✧ Personal digital assistants (PDA's)
- ✧ Microprocessors based equipment
- ✧ Notebooks, Desktops, and Servers
- ✧ Cell phone Handsets and Accessories
- ✧ Portable Electronics
- ✧ Peripherals

PIN CONFIGURATION

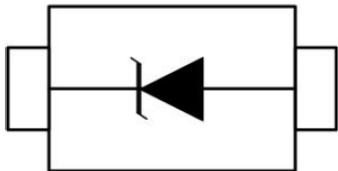

PACKAGE OUTLINE



Single Line Uni-directional Transient Voltage Suppressor

ABSOLUTE MAXIMUM RATING

Symbol	Parameter	Value	Units
V _{ESD}	ESD per IEC 61000-4-2 (Contact)	±30	kV
	ESD per IEC 61000-4-2 (Air)	±30	
P _{PP}	Peak Pulse Power (8/20μs)	1800	W
T _{OPT}	Operating Temperature	-55~125	°C
T _{STG}	Storage Temperature	-55~150	°C
T _L	Lead Soldering Temperature	260(10sec)	°C

ELECTRICAL CHARACTERISTICS (T_{amb}=25°C)

Symbol	Parameter	Test Condition	Min	Typ	Max	Units
V _{RWM}	Reverse Working Voltage				15	V
V _{BR}	Reverse Breakdown Voltage	I _T = 1mA	16	16.5	18	V
I _R	Reverse Leakage Current	V _{RWM} = 15V			1	uA
I _{PP}	Peak Pulse Current	t _p = 8/20μs			60	A
V _C	Clamping Voltage	I _{PP} = 25A, t _p = 8/20μs			22	V
		I _{PP} = 50A, t _p = 8/20μs			26	V
		I _{PP} = 60A, t _p = 8/20μs			30	V
C _J	Junction Capacitance	V _R = 0V, f = 1MHz	300	330	400	pF

ELECTRICAL CHARACTERISTICS CURVE

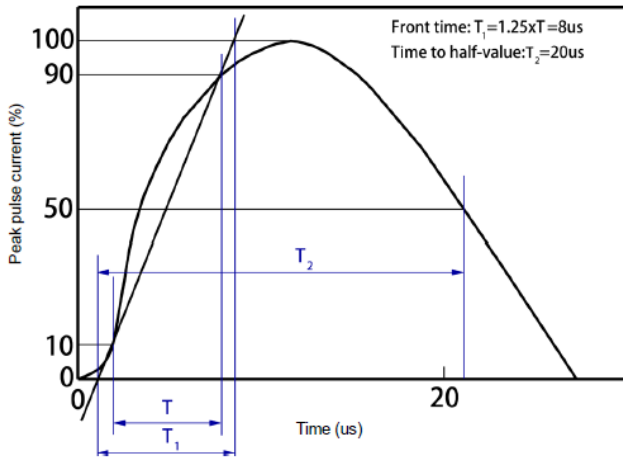

8/20 us waveform per IEC61000-4-5

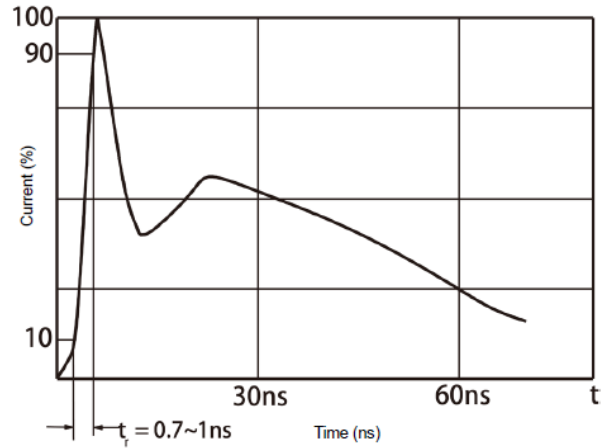

Contact discharge current waveform per IEC61000-4-2

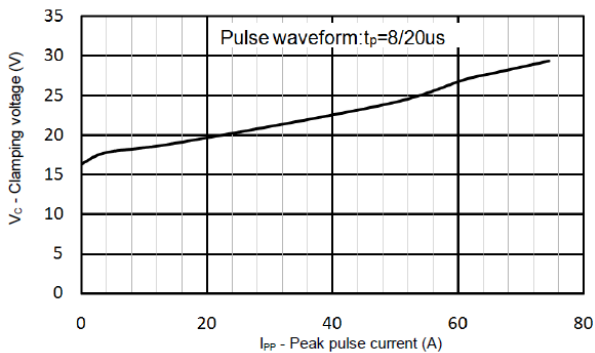

Clamping voltage vs. Peak pulse current

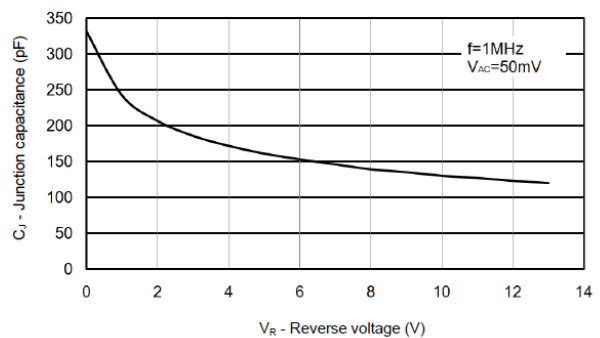

Capacitance vs. Reverse voltage

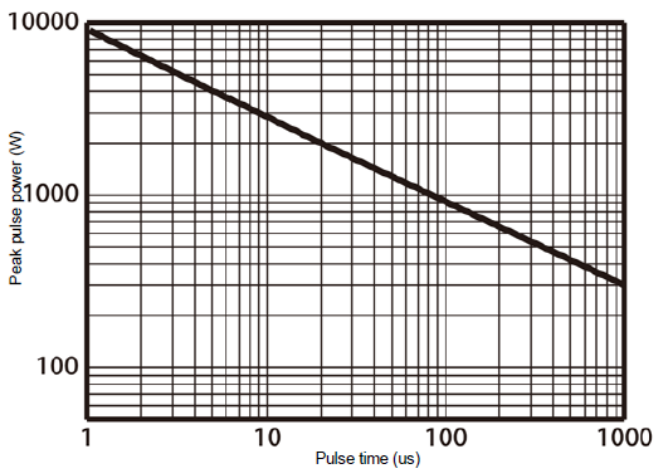

Non-repetitive peak pulse power vs. Pulse time

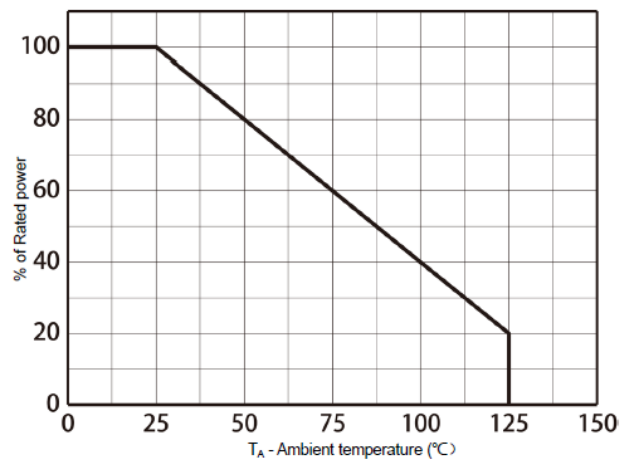

Power derating vs. Ambient temperature

SOD-323 PACKAGE OUTLINE DIMENSIONS

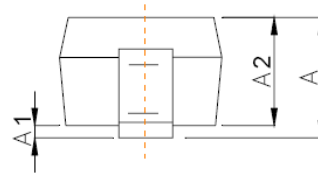
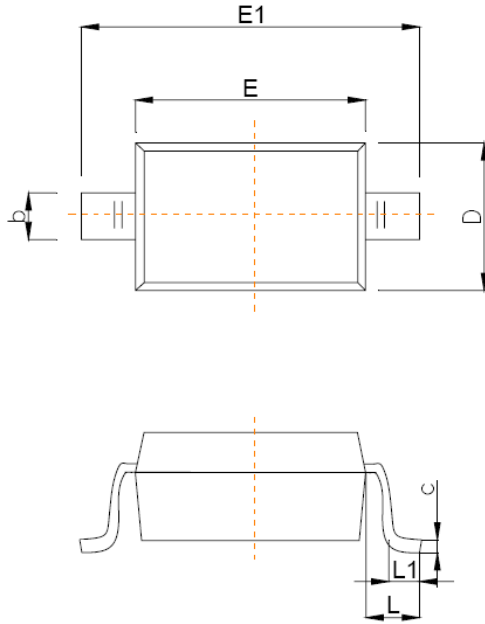

Symbol	Dimensions In Millimeters	
	Min	Max
A		1.00
A1	0.000	0.100
A2	0.800	0.900
b	0.250	0.350
c	0.080	0.150
D	1.200	1.400
E	1.600	1.800
E1	2.500	2.700
e	1.800	2.040
L	0.475 REF	
L1	0.250	0.400
θ	0°	8°

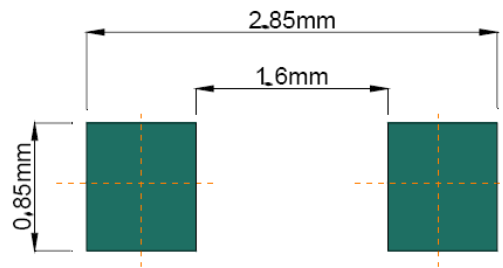

Recommended Pad outline