

## Ultra Low Capacitance ESD Protection Diode

### DESCRIPTION

GESD1501BU is an ultra low capacitance Transient Voltage Suppressor (TVS) designed to provide electrostatic discharge (ESD) protection for high-speed data interfaces. With typical capacitance of 0.25pF, GESD1501BU is designed to protect parasitic-sensitive systems against over-voltage and over-current transient events. It complies with IEC 61000-4-2 (ESD), Level 4 ( $\pm 15\text{kV}$  air,  $\pm 8\text{kV}$  contact discharge), very fast charged device model (CDM) ESD and cable discharge event (CDE), etc.

GESD1501BU uses ultra-small DFN1006 package. Each GESD1501BU device can protect one high-speed data line. It offers system designers flexibility to protect single data line where space is a premium concern. The combined features of low capacitance, ultra-small size and high ESD robustness make GESD1501BU ideal for high-speed data port and high-frequency line applications.

### ORDERING INFORMATION

- ✧ Device: GESD1501BU
- ✧ Package: DFN1006
- ✧ Marking: 15BU
- ✧ Material: Halogen free
- ✧ Packing: Tape & Reel
- ✧ Quantity per reel: 10,000pcs

### PIN CONFIGURATION

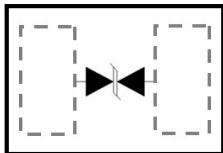

### FEATURES

- ✧ Transient protection for high-speed data lines  
IEC 61000-4-2 (ESD)  $\pm 15\text{kV}$  (Contact)  
 $\pm 20\text{kV}$  (Air)  
Cable Discharge Event (CDE)
- ✧ Package optimized for high-speed lines
- ✧ Ultra-small package (1.0mm×0.6mm×0.5mm)
- ✧ Protects one data, control line
- ✧ Low capacitance: 0.25pF (Typical)
- ✧ Low leakage current
- ✧ Low clamping voltage

### MACHANICAL DATA

- ✧ DFN1006 package
- ✧ Flammability Rating: UL 94V-0
- ✧ High temperature soldering guaranteed:  
 $260^{\circ}\text{C}/10\text{s}$
- ✧ Packaging: Tape and Reel
- ✧ Reel size: 7 inch

### APPLICATIONS

- ✧ Local Area Network (LAN) equipment
- ✧ FireWire
- ✧ Computers and peripherals
- ✧ Communication systems
- ✧ High-speed data lines

### PACKAGE OUTLINE



## Ultra Low Capacitance ESD Protection Diode

### ABSOLUTE MAXIMUM RATING

Symbol	Parameter	Value	Units
$V_{ESD}$	ESD per IEC 61000-4-2 (Contact)	$\pm 15$	kV
	ESD per IEC 61000-4-2 (Air)	$\pm 20$	
$P_{PP}$	Peak Pulse Power (8/20 $\mu$ s)	70	W
$T_{OPT}$	Operating Temperature	-55~125	$^{\circ}$ C
$T_{STG}$	Storage Temperature	-55~150	$^{\circ}$ C

### ELECTRICAL CHARACTERISTICS ( $T_{amb}=25^{\circ}$ C)

Symbol	Parameter	Test Condition	Min	Typ	Max	Units
$V_{RWM}$	Reverse Working Voltage				15.0	V
$V_{BR}$	Reverse Breakdown Voltage	$I_T = 1mA$	16			V
$I_R$	Reverse Leakage Current	$V_{RWM} = 15V$			500	nA
$V_C$	Clamping Voltage	$I_{PP} = 1A, t_p = 8/20\mu s$			25	V
		$I_{PP} = 2A, t_p = 8/20\mu s$			35	V
$C_J$	Junction Capacitance	$V_R = 0V, f = 1MHz$		0.25	0.40	pF

### ELECTRICAL CHARACTERISTICS CURVE

Fig 1 Power Derating Curve

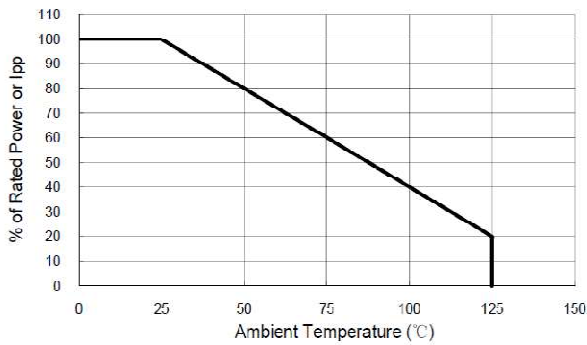

Fig 2 8/20μs Waveform per IEC61000-4-5

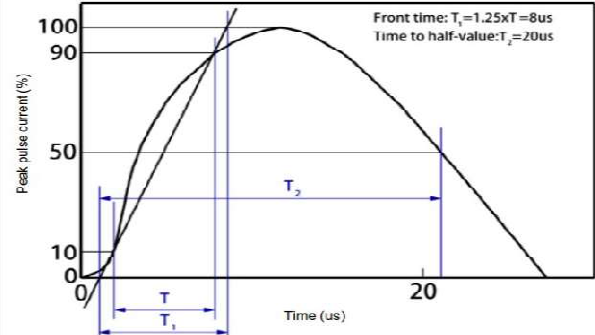

Fig 3 Clamping Voltage vs Peak Pulse Current

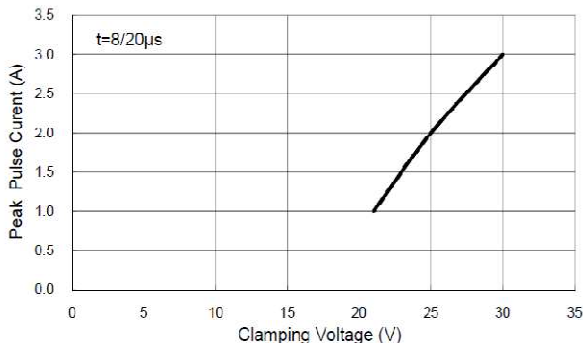

Fig 4 Voltage vs Capacitance

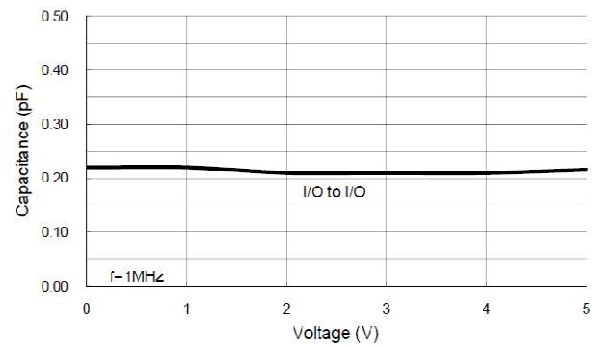

Fig 5 ESD Clamping of I/O to GND (+8kV Contact per IEC 61000-4-2)

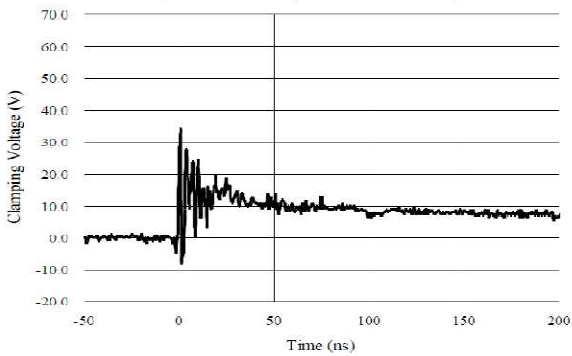
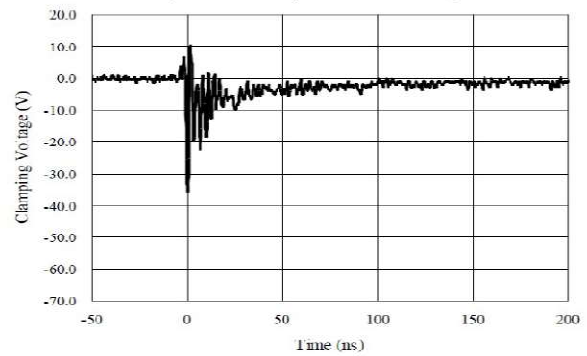
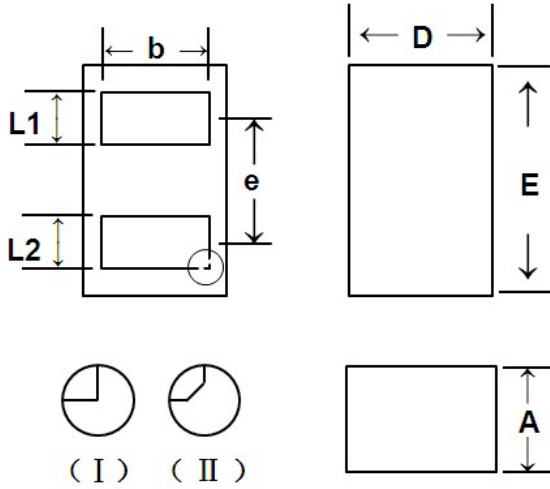

Fig 6 ESD Clamping of I/O to GND (-8kV Contact per IEC 61000-4-2)



## DFN1006 PACKAGE OUTLINE DIMENSIONS



NOTE: ALL DIMENSIONS IN MM

	MIN	NOM	MAX
<b>D</b>	<b>0.55</b>	<b>0.60</b>	<b>0.65</b>
<b>E</b>	<b>0.95</b>	<b>1.00</b>	<b>1.05</b>
<b>L1</b>	<b>0.20</b>	<b>0.25</b>	<b>0.30</b>
<b>L2</b>	<b>0.20</b>	<b>0.25</b>	<b>0.30</b>
<b>A</b>	<b>0.45</b>	<b>0.50</b>	<b>0.55</b>
<b>b</b>	<b>0.45</b>	<b>0.50</b>	<b>0.55</b>
<b>e</b>		<b>0.64BSC</b>	

