

DESCRIPTION

The GBLC03CW is an ultra low capacitance ESD and Surge Protector designed to provide electrostatic discharge (ESD) protection for high-speed data interfaces. GBLC03CW is designed to protect parasitic-sensitive systems against over-voltage and over-current transient events. It complies with IEC 61000-4-2 (ESD), Level 4 ($\pm 15\text{kV}$ air, $\pm 8\text{kV}$ contact discharge), IEC 61000-4-4 (EFT, 40A 5/50ns), IEC 61000-4-5 (Surge, 17A 8/20 μs), very fast charged device model (CDM) ESD and cable discharge event (CDE), etc.

GBLC03CW is in an SOD-323 package. The combined features of ultra-low capacitance and high ESD robustness make GBLC03CW ideal for applications where arrays are not practical. The low clamping voltage of GBLC03CW guarantees a minimum stress on the protected IC.

FEATURES

- ✧ Transient protection for high-speed data lines
IEC 61000-4-2 (ESD) $\pm 30\text{kV}$ (Contact)
 $\pm 30\text{kV}$ (Air)
- ✧ IEC61000-4-4 (EFT) 40A (5/50ns)
- ✧ IEC61000-4-5 (Surge) 17A (8/20 μs)
- ✧ Protects one I/O line (bidirectional)
- ✧ Low operating and clamping voltage
- ✧ Low leakage current

MACHANICAL DATA

- ✧ SOD-323 package
- ✧ Flammability Rating: UL 94V-0
- ✧ Packaging: Tape and Reel
- ✧ High temperature soldering guaranteed:
260 $^{\circ}\text{C}$ /10s
- ✧ Reel size: 7 inch

ORDERING INFORMATION

- ✧ Device: GBLC03CW
- ✧ Package: SOD-323
- ✧ Marking: CA1
- ✧ Material: Halogen free
- ✧ Packing: Tape & Reel
- ✧ Quantity per reel: 3,000pcs

APPLICATIONS

- ✧ Cell Phone Handsets and Accessories
- ✧ Microprocessor based equipment
- ✧ Personal Digital Assistants (PDA's)
- ✧ Notebooks, Desktops, and Servers
- ✧ Portable Instrumentation
- ✧ Peripherals
- ✧ Analog Inputs

PIN CONFIGURATION

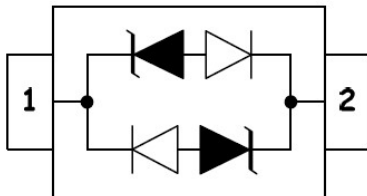

PACKAGE OUTLINE



ABSOLUTE MAXIMUM RATING

Symbol	Parameter	Value	Units
V_{ESD}	ESD per IEC 61000-4-2 (Contact)	± 30	kV
	ESD per IEC 61000-4-2 (Air)	± 30	
P_{PP}	Peak Pulse Power (8/20 μ s)	289	W
I_{PP}	Peak Pulse Current (8/20 μ s)	17	A
T_{OPT}	Operating Temperature	-45 ~ +85	$^{\circ}$ C
T_{STG}	Storage Temperature	-55 ~ +150	$^{\circ}$ C

ELECTRICAL CHARACTERISTICS (Tamb=25 $^{\circ}$ C)

Symbol	Parameter	Test Condition	Min	Typ	Max	Units
V_{RWM}	Reverse Working Voltage				3.3	V
V_B	Reverse Breakdown Voltage	$I_R = 1mA$	3.5			V
I_R	Reverse Leakage Current	$V_{RWM} = 3.3V$			500	nA
V_{C1}	Clamping Voltage 1	$I_{PP} = 1A, t_p = 8/20\mu s$			6.5	V
V_{C2}	Clamping Voltage 2	$I_{PP} = 10A, t_p = 8/20\mu s$			15.0	V
V_{C3}	Clamping Voltage 3	$I_{PP} = 17A, t_p = 8/20\mu s$			17.0	V
C_{ESD}	Parasitic Capacitance	$V_R = 0V, f = 1MHz$			1.0	pF

ELECTRICAL CHARACTERISTICS CURVE

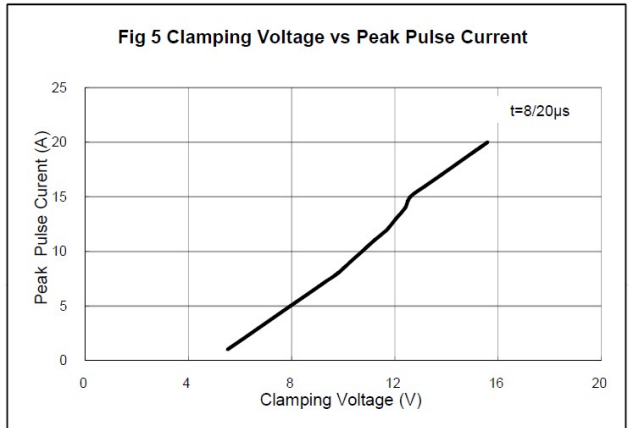
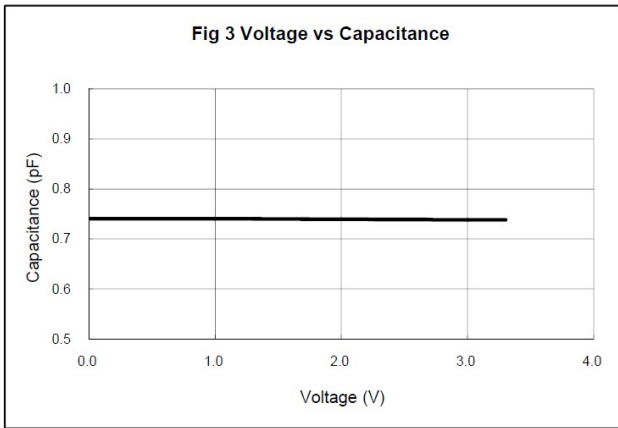
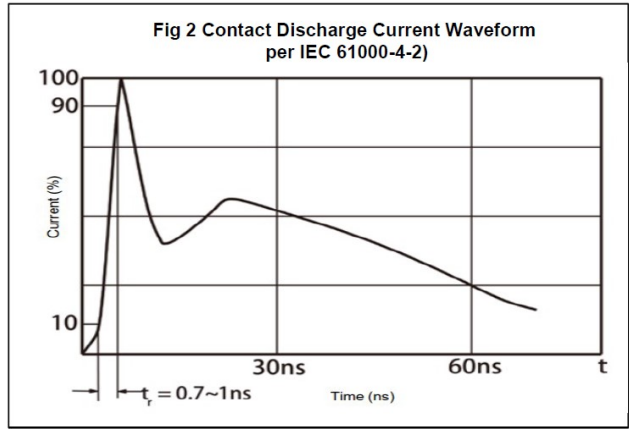
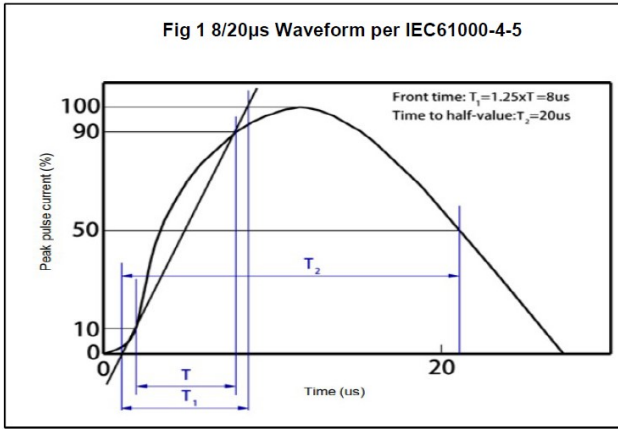

SOD-323 PACKAGE OUTLINE DIMENSIONS

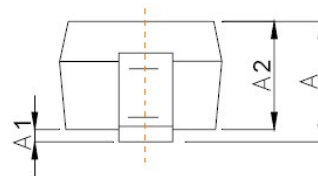
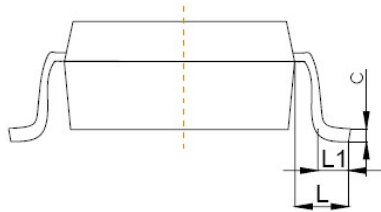
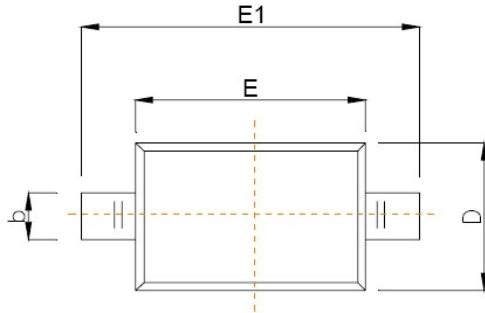

Symbol	Dimensions In Millimeters	
	Min	Max
A		1.00
A1	0.000	0.100
A2	0.800	0.900
b	0.250	0.350
c	0.080	0.150
D	1.200	1.400
E	1.600	1.800
E1	2.500	2.700
e	1.800	2.040
L	0.475 REF	
L1	0.250	0.400
θ	0°	8°

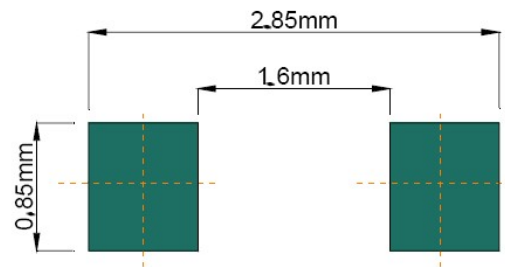

Recommended Pad outline