

### DESCRIPTION

The GBLCxxC Series are ultra low capacitance transient voltage suppressor arrays, designed to protect applications such as portable electronics and SMART phones. This series is available in bidirectional configurations and is rated at 300 Watts for an 8/20 $\mu$ s wave shape.

The GBLCxxC Series meets IEC 61000-4-2 (ESD) and IEC 61000-4-4 (EFT) requirements. At higher operating frequencies or faster edge rates, insertion loss and signal integrity are a major concern. This series offers ultra low capacitance and low leakage current in a miniature SOD-323 package.

### ORDERING INFORMATION

- ✧ Device: GBLCxxC
- ✧ Package: SOD-323
- ✧ Material: Halogen free
- ✧ Packing: Tape & Reel
- ✧ Quantity per reel: 3,000pcs

### PIN CONFIGURATION

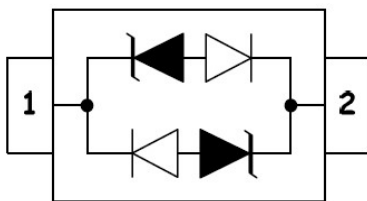

### FEATURES

- ✧ IEC61000-4-2 (ESD)  $\pm$ 8kV (Contact),  $\pm$ 15kV (Air)
- ✧ IEC61000-4-4 (EFT) 40A (5/50ns)
- ✧ Protects one I/O line (bidirectional)
- ✧ Low clamping voltage
- ✧ Working voltages: 3V, 5V, 8V, 12V, 15V, 24V
- ✧ Low leakage current
- ✧ Response Time is < 1 ns

### MACHANICAL DATA

- ✧ SOD-323 package
- ✧ Flammability Rating: UL 94V-0
- ✧ Packaging: Tape and Reel
- ✧ High temperature soldering guaranteed: 260 $^{\circ}$ C/10s
- ✧ Reel size: 7 inch

### APPLICATIONS

- ✧ Cell Phone Handsets and Accessories
- ✧ Microprocessor based equipment
- ✧ Personal Digital Assistants (PDA's)
- ✧ Notebooks, Desktops, and Servers
- ✧ Portable Instrumentation
- ✧ Peripherals
- ✧ USB Interface

### PACKAGE OUTLINE



## ABSOLUTE MAXIMUM RATING

Symbol	Parameter	Value	Units
$V_{ESD}$	ESD per IEC 61000-4-2 (Contact)	±8	kV
	ESD per IEC 61000-4-2 (Air)	±15	
$P_{PP}$	Peak Pulse Power (8/20μs)	300	W
$T_{OPT}$	Operating Temperature	-55/+150	°C
$T_{STG}$	Storage Temperature	-55/+150	°C
$T_L$	Lead Soldering Temperature	260	°C

## ELECTRICAL CHARACTERISTICS (Tamb=25°C)

PART NUMBER	DEVICE MARKING	$V_{RWM}$ (V) (max.)	$V_B$ (V) (min.)	$I_T$ (mA)	$V_C@1A$ (V) (max.)	$V_C$ (V) (max.) (@A)	$I_R$ (μA) (max.)	$C_T$ (pF) (typ.)	
GBLC03C	CC	3.0	4.0	1	7.0	13.9	8	2	0.8
GBLC05C	AC	5.0	6.0	1	9.8	18.3	8	1	0.8
GBLC08C	BC	8.0	8.5	1	13.4	18.5	8	1	0.8
GBLC12C	DC	12.0	13.3	1	19.0	28.6	6	1	0.8
GBLC15C	EC	15.0	16.7	1	24.0	31.8	5	1	0.8
GBLC24C	HC	24.0	26.7	1	43.0	56.0	3	1	0.8

## ELECTRICAL CHARACTERISTICS CURVE

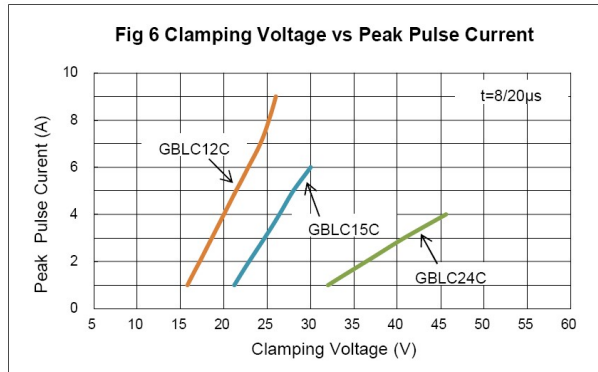
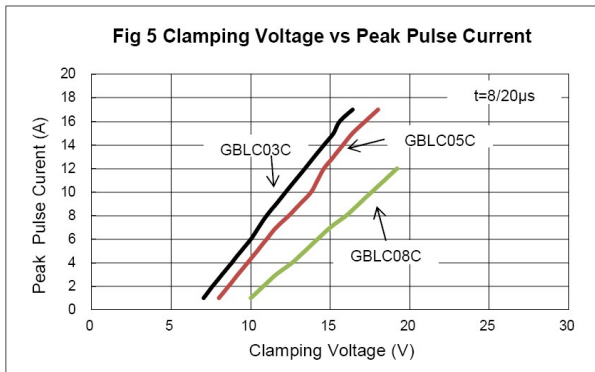
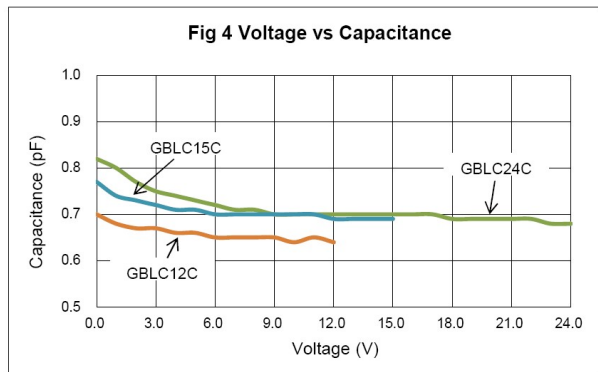
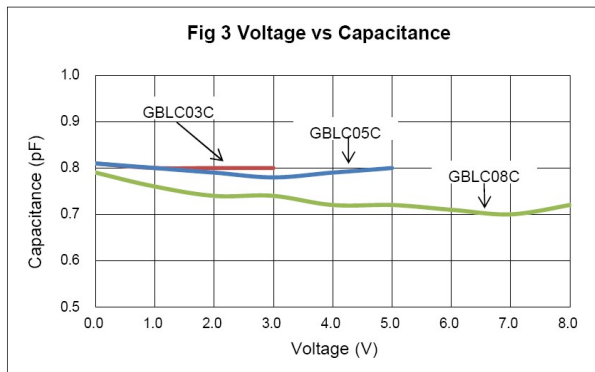
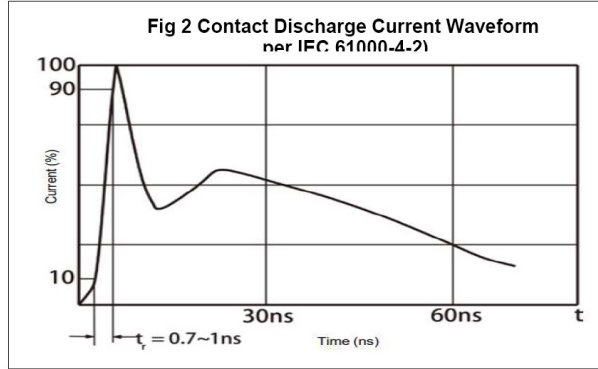
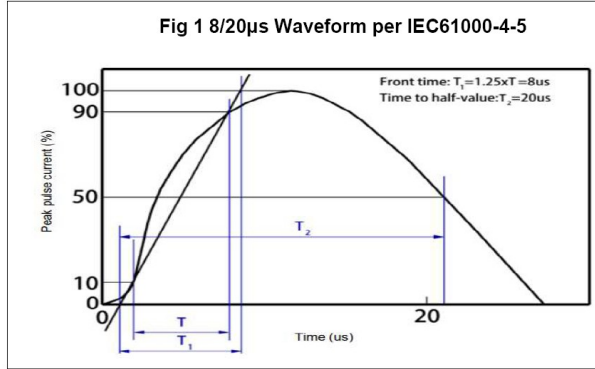

## SOD-323 PACKAGE OUTLINE DIMENSIONS

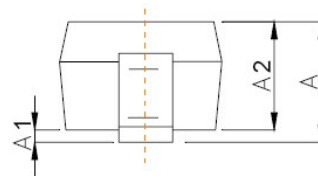
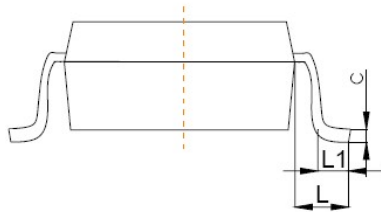
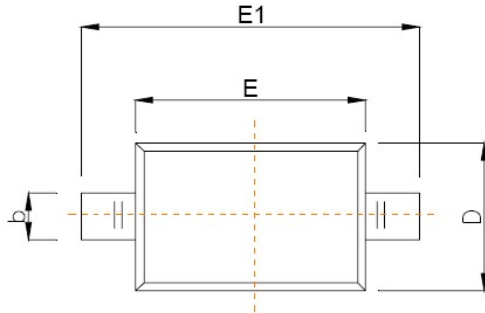

Symbol	Dimensions In Millimeters	
	Min	Max
A		1.00
A1	0.000	0.100
A2	0.800	0.900
b	0.250	0.350
c	0.080	0.150
D	1.200	1.400
E	1.600	1.800
E1	2.500	2.700
e	1.800	2.040
L	0.475 REF	
L1	0.250	0.400
θ	0°	8°

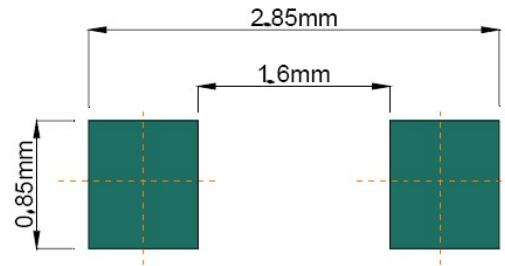

**Recommended Pad outline**