

## Surface Mount Schottky Barrier Rectifier

### Surface Mount Schottky Barrier Rectifier

Reverse Voltage - 40V

Forward Current - 3.0A

#### FEATURES

- Metal silicon junction, majority carrier conduction
- For surface mounted applications
- Low power loss, high efficiency
- High forward surge current capability
- For use in low voltage, high frequency inverters, free wheeling, and polarity protection applications

#### MECHANICAL DATA

- Case: SMBF
- Terminals: Solderable per MIL-STD-750, Method 2026
- Approx. Weight: 57mg / 0.002oz

#### PINNING

PIN	DESCRIPTION
1	Cathode
2	Anode

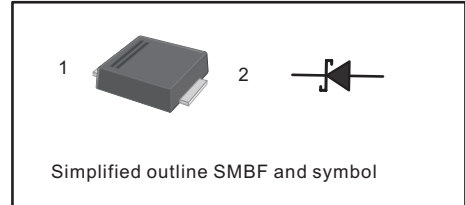

#### Absolute Maximum Ratings and Electrical characteristics

Ratings at 25 °C ambient temperature unless otherwise specified. Single phase, half wave, 60Hz resistive or inductive load, for capacitive load, derate by 20 %

Parameter	Symbols	SSL34BF	Units
Maximum Repetitive Peak Reverse Voltage	$V_{RRM}$	40	V
Maximum RMS voltage	$V_{RMS}$	28	V
Maximum DC Blocking Voltage	$V_{DC}$	40	V
Maximum Average Forward Rectified Current	$I_{F(AV)}$	3.0	A
Peak Forward Surge Current, 8.3ms Single Half Sine-wave Superimposed on Rated Load (JEDEC method)	$I_{FSM}$	80	A
Max Instantaneous Forward Voltage at 3 A	$V_F$	0.45	V
Maximum DC Reverse Current $T_a = 25^{\circ}C$ at Rated DC Reverse Voltage $T_a = 100^{\circ}C$	$I_R$	0.3 5	mA
Typical Junction Capacitance <sup>1)</sup>	$C_j$	450	pF
Typical Thermal Resistance <sup>2)</sup>	$R_{\theta JA}$	50	$^{\circ}C/W$
Operating Junction Temperature Range	$T_j$	-55 ~ +125	$^{\circ}C$
Storage Temperature Range	$T_{stg}$	-55 ~ +150	$^{\circ}C$

1) Measured at 1MHz and applied reverse voltage of 4 V D.C.

2) P.C.B. mounted with 0.5 X 0.5" (12.7 X 12.7 mm) copper pad areas.

**Fig.1 Forward Current Derating Curve**

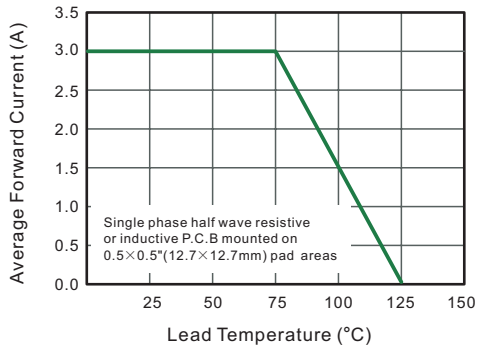

**Fig.2 Typical Reverse Characteristics**

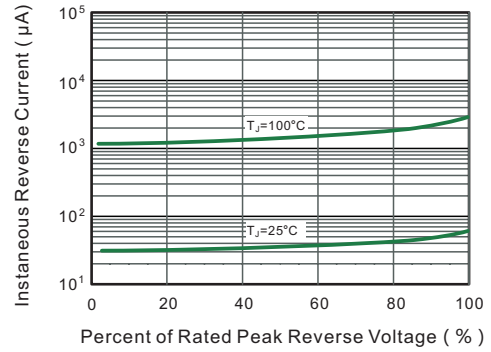

**Fig.3 Typical Forward Characteristic**

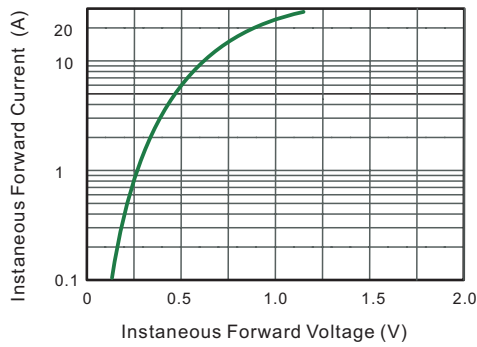

**Fig.4 Typical Junction Capacitance**

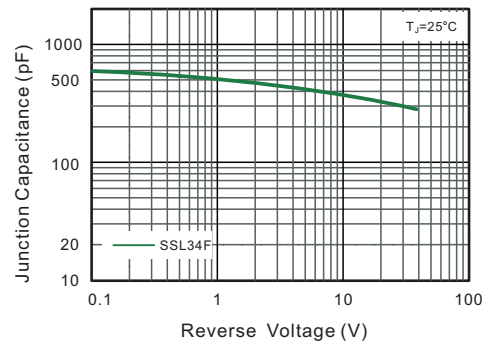

**Fig.5 Maximum Non-Repetitive Peak Forward Surge Current**

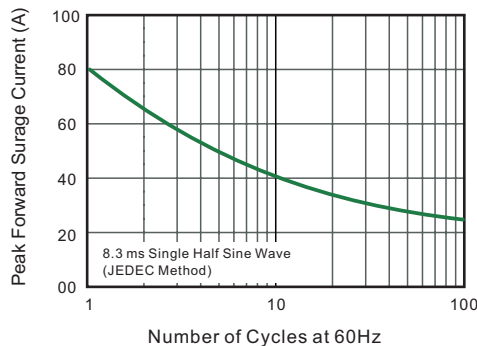

**Fig.6- Typical Transient Thermal Impedance**

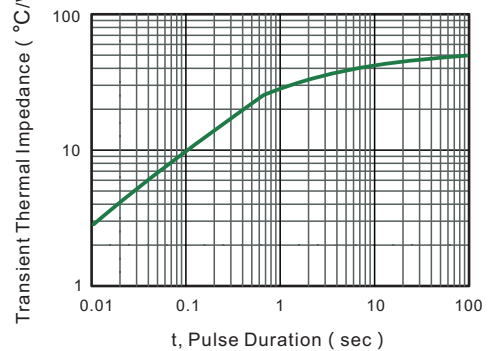

### PACKAGE OUTLINE

Plastic surface mounted package; 2 leads

SMBF

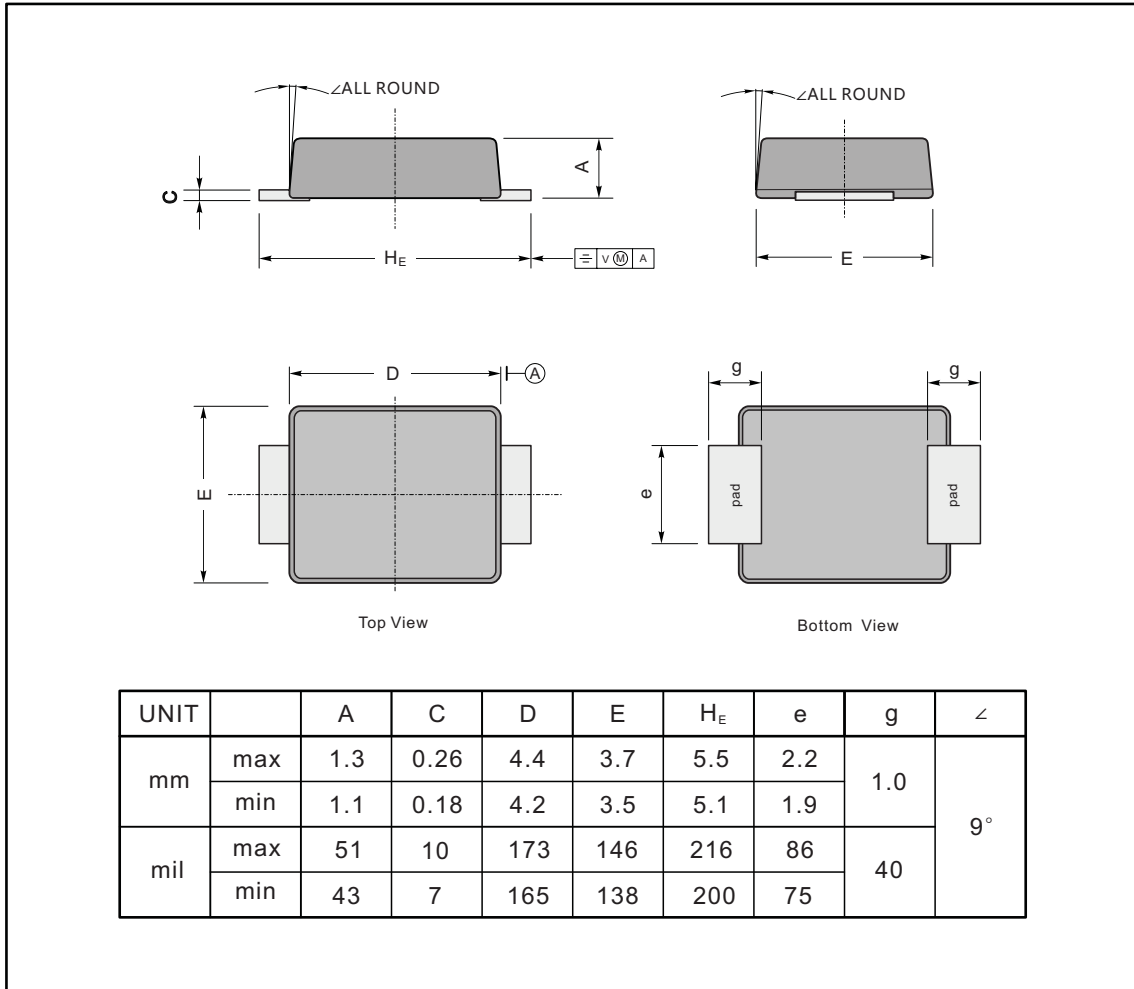

### The recommended mounting pad size

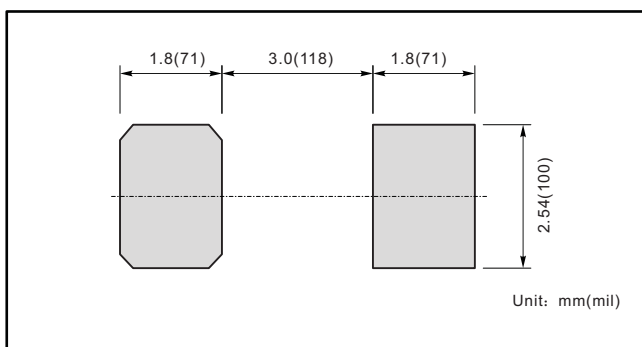

### Marking

Type number	Marking code
SSL34BF	SL34B