

Surface Mount Schottky Barrier Rectifier

Surface Mount Schottky Barrier Rectifier

Reverse Voltage - 45V

Forward Current - 3.0A

Features

- Metal silicon junction, majority carrier conduction
- For surface mounted applications
- Low power loss, high efficiency
- High forward surge current capability
- For use in low voltage, high frequency inverters, free wheeling, and polarity protection applications

MECHANICAL DATA

- Case: SMAF
- Terminals: Solderable per MIL-STD-750, Method 2026
- Approx. Weight: 27mg / 0.00095oz

PINNING

PIN	DESCRIPTION
1	Cathode
2	Anode

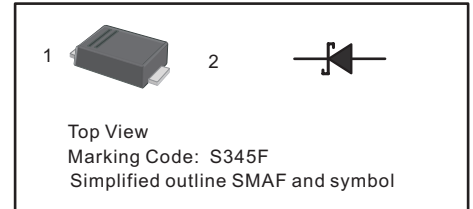

Maximum Ratings and Electrical characteristics

Ratings at 25 °C ambient temperature unless otherwise specified.

Single phase half-wave 60 Hz, resistive or inductive load, for capacitive load current derate by 20 %.

Parameter	Symbols	SSL345F	Units
Maximum Repetitive Peak Reverse Voltage	V_{RRM}	45	V
Maximum RMS voltage	V_{RMS}	32	V
Maximum DC Blocking Voltage	V_{DC}	45	V
Maximum Average Forward Rectified Current at $T_c=100\text{ }^\circ\text{C}$	$I_{F(AV)}$	3	A
Peak Forward Surge Current 8.3 ms Single Half Sine Wave Superimposed on Rated Load	I_{FSM}	80	A
Maximum Instantaneous Forward Voltage at 3 A	V_F	0.45	V
Maximum DC Reverse Current at Rated DC Blocking Voltage $T_a=25\text{ }^\circ\text{C}$ $T_a=100\text{ }^\circ\text{C}$	I_R	0.3 5	mA
Typical Junction Capacitance ⁽¹⁾	C_j	300	pF
Typical Thermal Resistance ⁽²⁾	$R_{\theta JA}$	60	$^\circ\text{C/W}$
Operating Junction Temperature Range	T_j	-55 ~ +150	$^\circ\text{C}$
Storage Temperature Range	T_{stg}	-55 ~ +150	$^\circ\text{C}$

(1) Measured at 1 MHz and applied reverse voltage of 4 V D.C

(2) P.C.B. mounted with 2.0" X 2.0" (5 X 5 cm) copper pad areas.

Fig.1 Forward Current Derating Curve

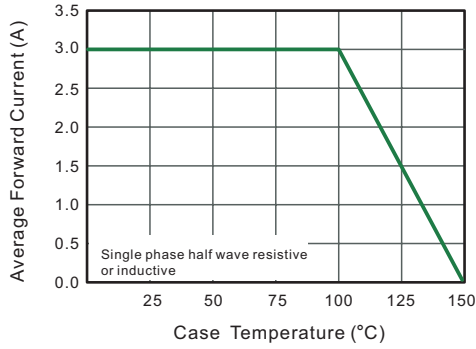

Fig.2 Typical Reverse Characteristics

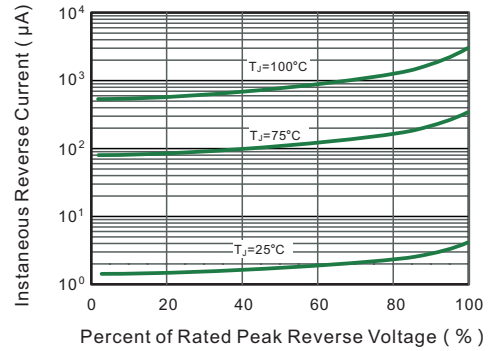

Fig.3 Typical Forward Characteristic

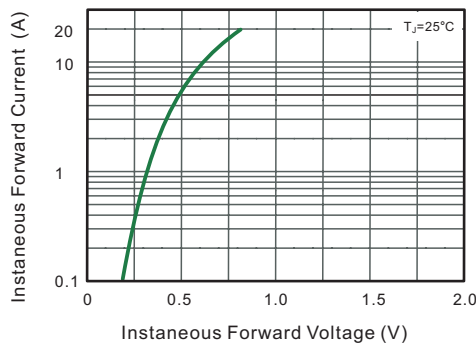

Fig.4 Typical Junction Capacitance

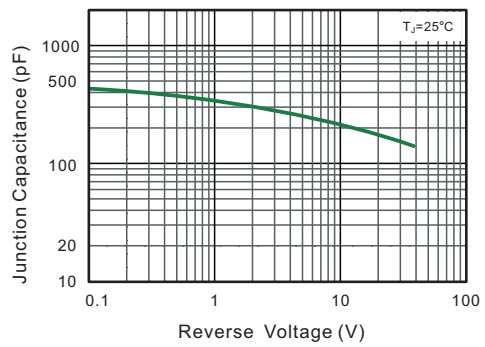

Fig.5 Maximum Non-Repetitive Peak Forward Surge Current

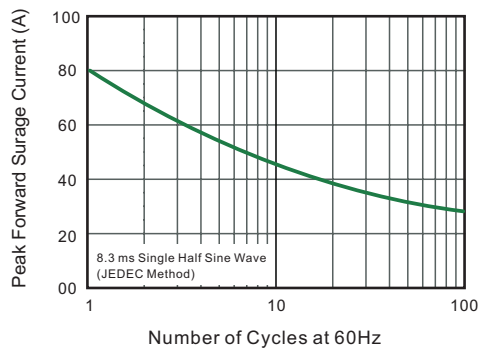
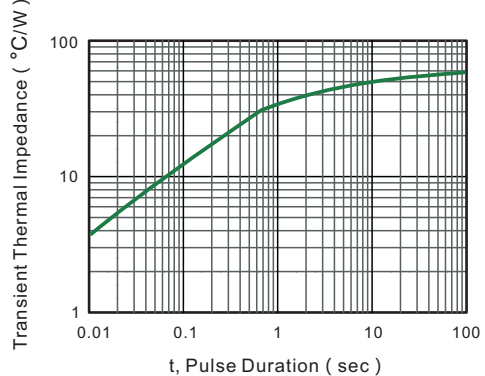

Fig.5- Typical Transient Thermal Impedance



PACKAGE OUTLINE

Plastic surface mounted package; 2 leads

SMAF

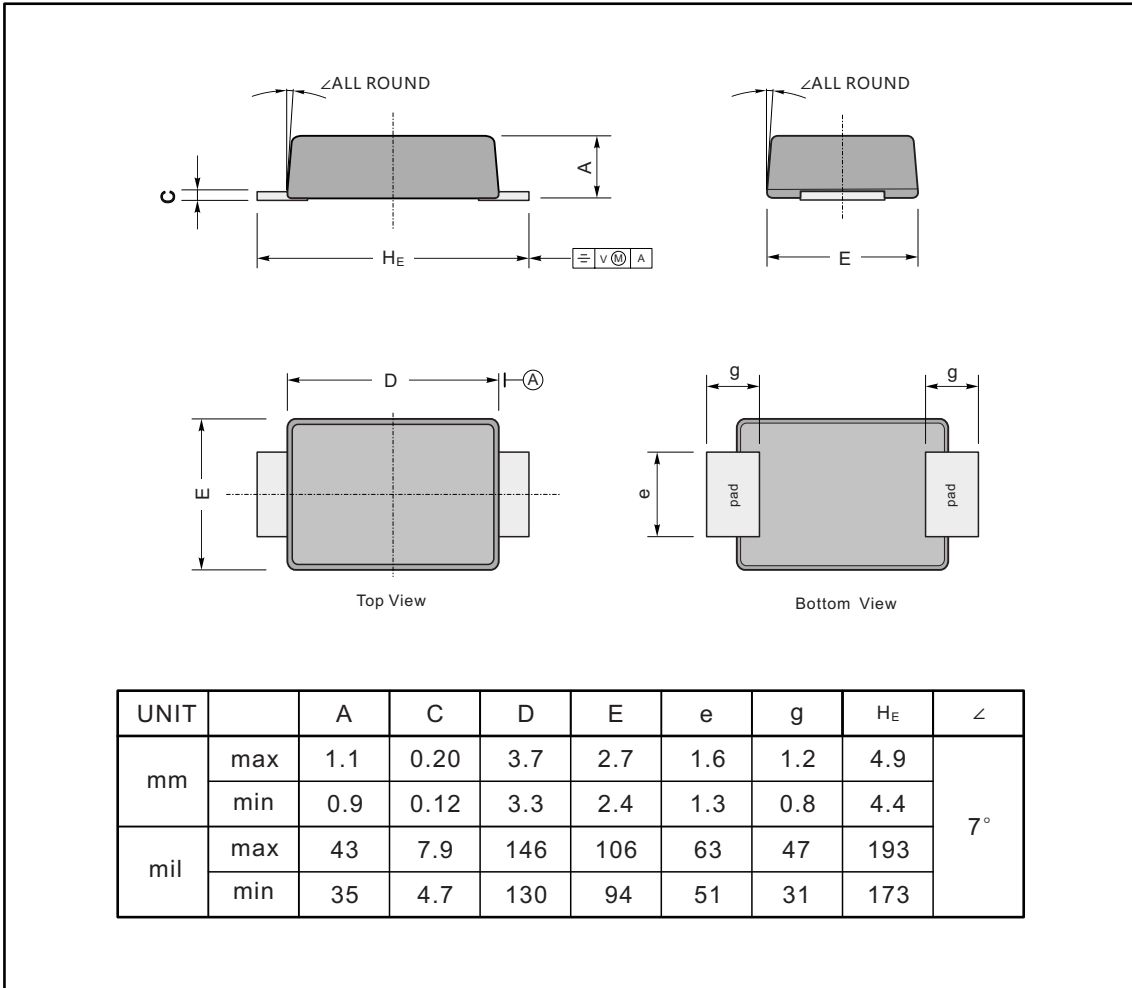

The recommended mounting pad size

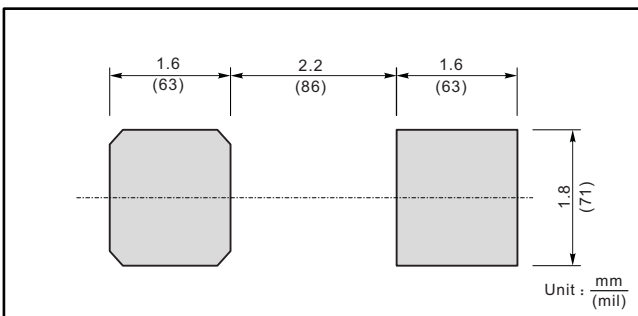

Marking

Type number	Marking code
SSL345F	S345F