

Surface Mount Schottky Barrier Rectifier

Reverse Voltage - 50 V

Forward Current - 2.0A

Features

- Metal silicon junction, majority carrier conduction
- For surface mounted applications
- Low power loss, high efficiency
- High forward surge current capability
- For use in low voltage, high frequency inverters, free wheeling, and polarity protection applications

PINNING

PIN	DESCRIPTION
1	Cathode
2	Anode

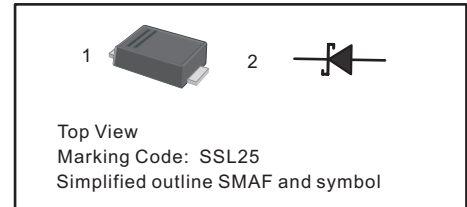

MECHANICAL DATA

- Case: SMAF
- Terminals: Solderable per MIL-STD-750, Method 2026
- Approx. Weight: 27mg / 0.00095oz

Absolute Maximum Ratings and Electrical characteristics

Ratings at 25 °C ambient temperature unless otherwise specified. Single phase, half wave, 60Hz resistive or inductive load, for capacitive load, derate by 20 %

Parameter	Symbols	SSL25F	Units
Maximum Repetitive Peak Reverse Voltage	V_{RRM}	50	V
Maximum RMS voltage	V_{RMS}	35	V
Maximum DC Blocking Voltage	V_{DC}	50	V
Maximum Average Forward Rectified Current	$I_{F(AV)}$	2.0	A
Peak Forward Surge Current, 8.3ms Single Half Sine-wave Superimposed on Rated Load (JEDEC method)	I_{FSM}	50	A
Max Instantaneous Forward Voltage at 2 A	V_F	0.5	V
Maximum DC Reverse Current $T_a = 25^\circ\text{C}$ at Rated DC Reverse Voltage $T_a = 100^\circ\text{C}$	I_R	0.4 10	mA
Typical Junction Capacitance ¹⁾	C_j	290	pF
Typical Thermal Resistance ²⁾	$R_{\theta JA}$	65	°C/W
Operating Junction Temperature Range	T_j	-55 ~ +125	°C
Storage Temperature Range	T_{stg}	-55 ~ +150	°C

1) Measured at 1MHz and applied reverse voltage of 4 V D.C.

2) P.C.B. mounted with 0.5 X 0.5" (12.7 X 12.7 mm) copper pad areas.

Fig.1 Forward Current Derating Curve

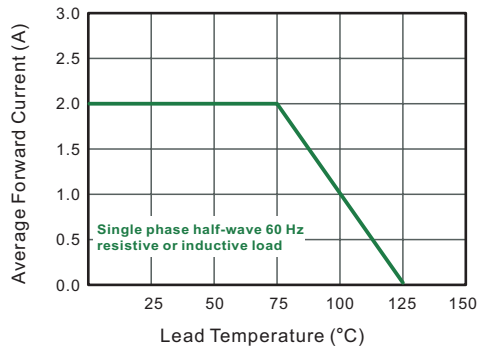

Fig.2 Typical Reverse Characteristics

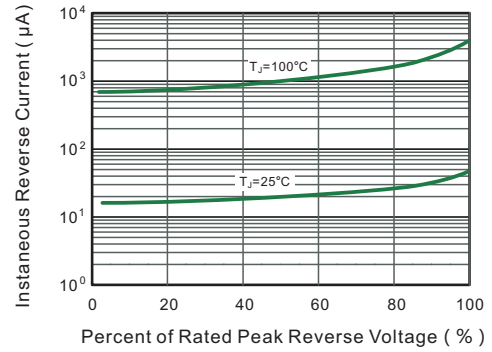

Fig.3 Typical Forward Characteristic

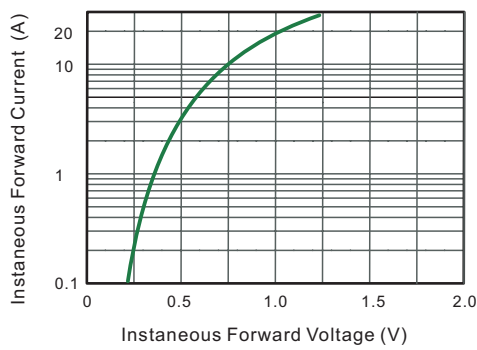

Fig.4 Typical Junction Capacitance

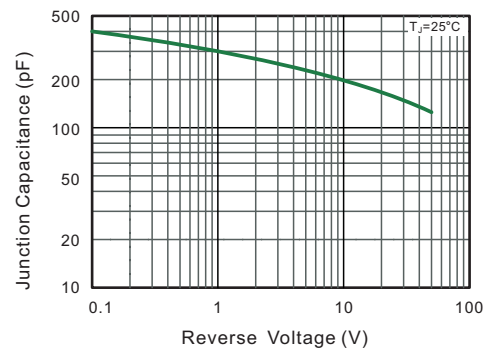

Fig.5 Maximum Non-Repetitive Peak Forward Surge Current

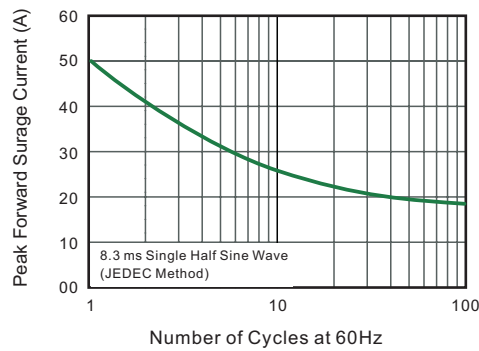
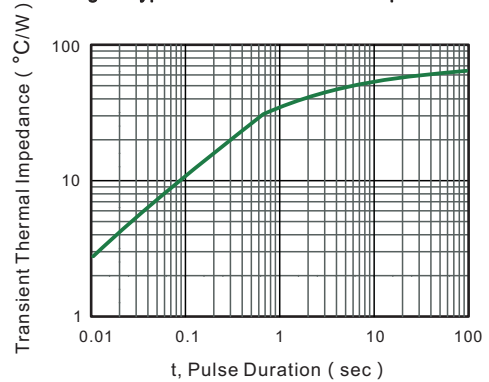

Fig.6- Typical Transient Thermal Impedance



PACKAGE OUTLINE

Plastic surface mounted package; 2 leads

SMAF

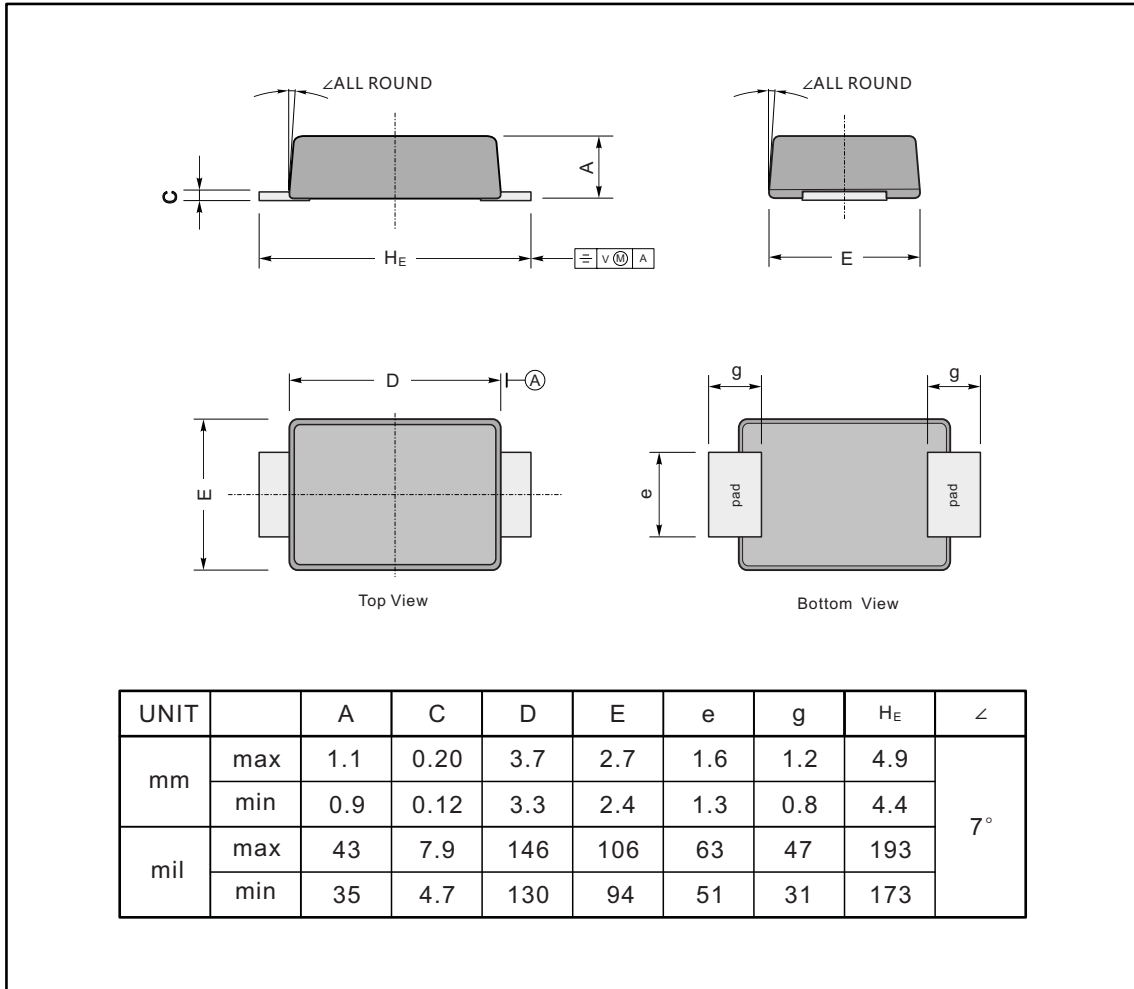

The recommended mounting pad size

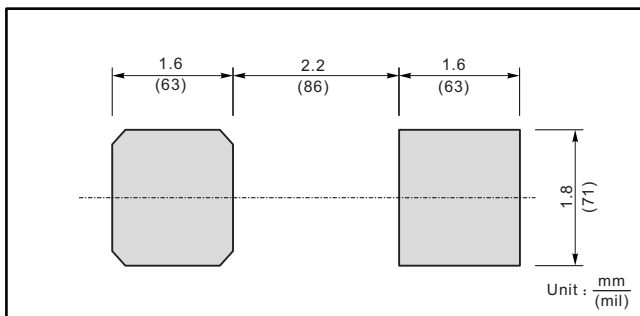

Marking

Type number	Marking code
SSL25F	SSL25