

MARKING: T4

特征 Features

- 开关速度小于 4.0nS; Fast Switching Device (TRR <4.0 nS)
- 最大功率耗散 200mW; Power Dissipation of 200mW
- 高稳定性和可靠性。High Stability and High Reliability
- 反向漏电流小。Low reverse leakage

机械数据 Mechanical Data

- 封装: SOD-323 封装 SOD-323 Small Outline Plastic Package
- 极性: 色环端为负极 Polarity: Color band denotes cathode end
- 安装位置: 任意 Mounting Position: Any

极限值和温度特性(TA = 25℃ 除非另有规定)

Maximum Ratings & Thermal Characteristics (Ratings at 25℃ ambient temperature unless otherwise specified.)

参数 Parameters	符号 Symbol	数值 Value	单位 Unit
反向电压 Reverse Voltage	V _R	71	V
反向峰值电压 Peak Reverse Voltage	V _{RM}	100	V
功率消耗 Power Dissipation	P _d	200	mW
工作结温 Operating junction temperature	T _J	150	℃
存储温度 Storage temperature range	T _s	-65-+150	℃
反向工作电压 Working Inverse Voltage	W _{IV}	75	V
平均整流电流 Average Rectified Current	I _O	150	mA
正向(不重复)电流 Non-repetitive Peak Forward Current	I _{FM}	300	mA
正向(不重复)浪涌电流 Peak Forward Surge Current @tp=1us; TA=25℃	I _{FSM}	2.0	A

Valid provided that electrodes are kept at ambient temperature.

电特性 **Electrical Characteristics** (Ratings at 25℃ ambient temperature unless otherwise specified).

符号 Symbols	参数 Parameter	测试条件 Test Condition	界限 Limits		单位 Unit
			Min	Max	
B _v	反向击穿电压 Breakdown Voltage	IR=100uA	100		V
		IR=5uA	75		
I _R	反向漏电流 Reverse Leakage Current	VR=20V	---	25	nA
		VR=75	---	1	uA
V _F	正向电压 Forward Voltage	IF=1.0mA	---	0.715	V
		IF=10mA	---	0.855	
		IF=50mA	---	1.00	
		IF=150mA	---	1.25	
TRR	反向恢复时间 Reverse Recovery Time	IF= IR=10mA RL=100Ω IRR=0.1 X IR	---	4	nS
CT	结电容 Capacitance	VR=0V, f=1MHZ	---	2	pF

Forward characteristics

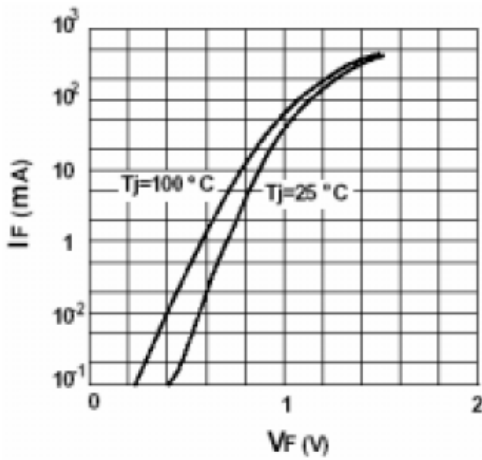

Admissible power dissipation versus ambient temperature

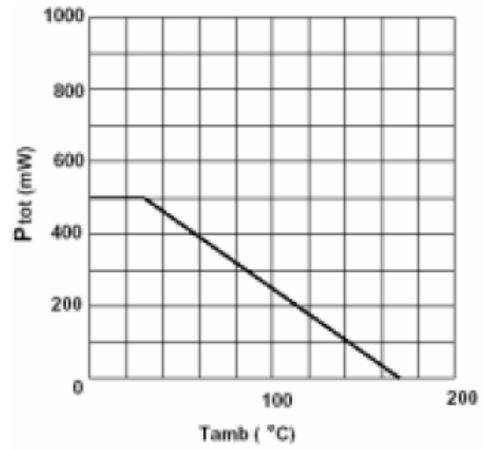

Leakage current versus junction temperature

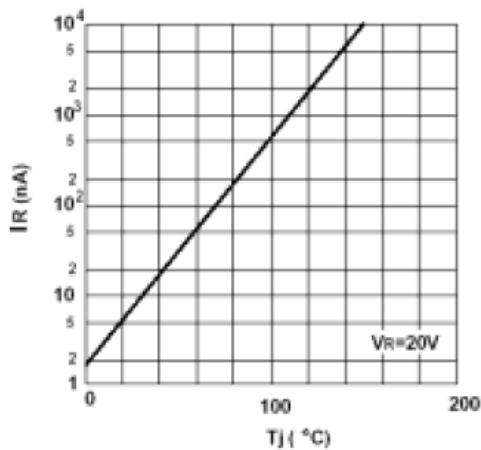

Reverse capacitance VS. reverse voltage

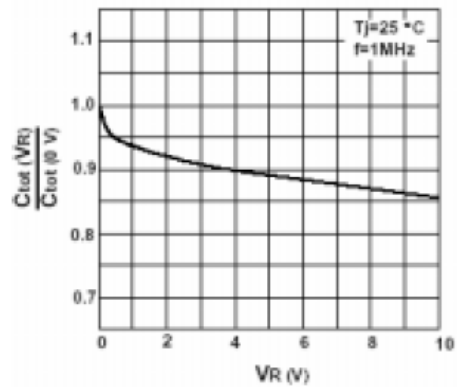

Admissible repetitive peak forward current VS. pulse duration

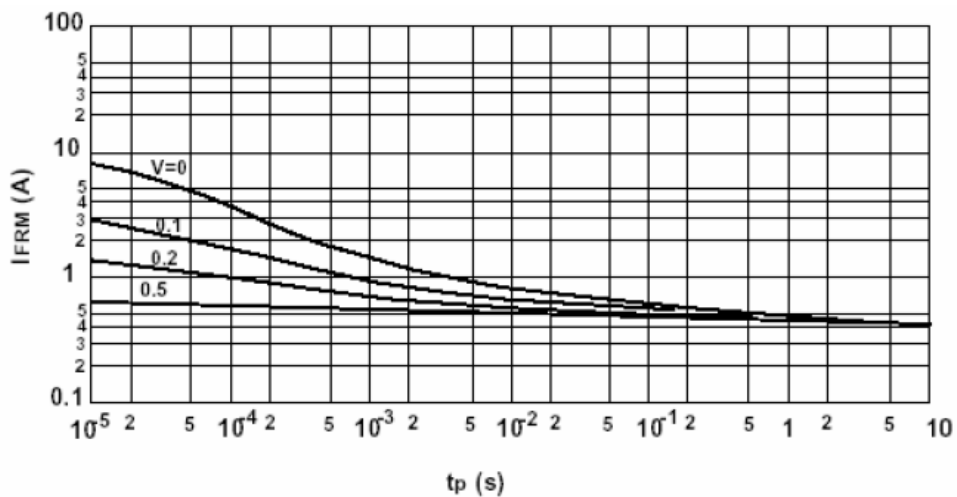

SOD-323 PACKAGE OUTLINE

Plastic surface mounted package

SOD-323

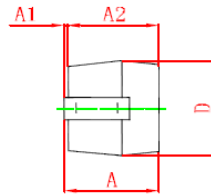
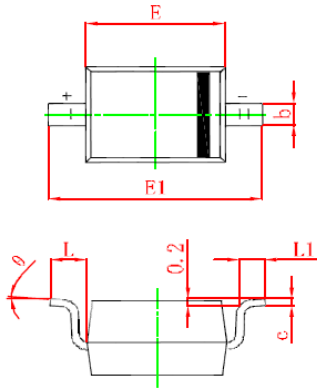

Symbol	Min.(mm)	Max.(mm)
A		1.000
A1	0.000	0.100
A2	0.800	0.900
b	0.250	0.350
c	0.080	0.150
D	1.200	1.400
E	1.600	1.800
E1	2.500	2.700
L	0.475REF	
L1	0.250	0.400
θ	0°	8°